

980.3st

Three Speed Self-Tailing Winch
Winch Parts, Installation, Service

HARKEN®

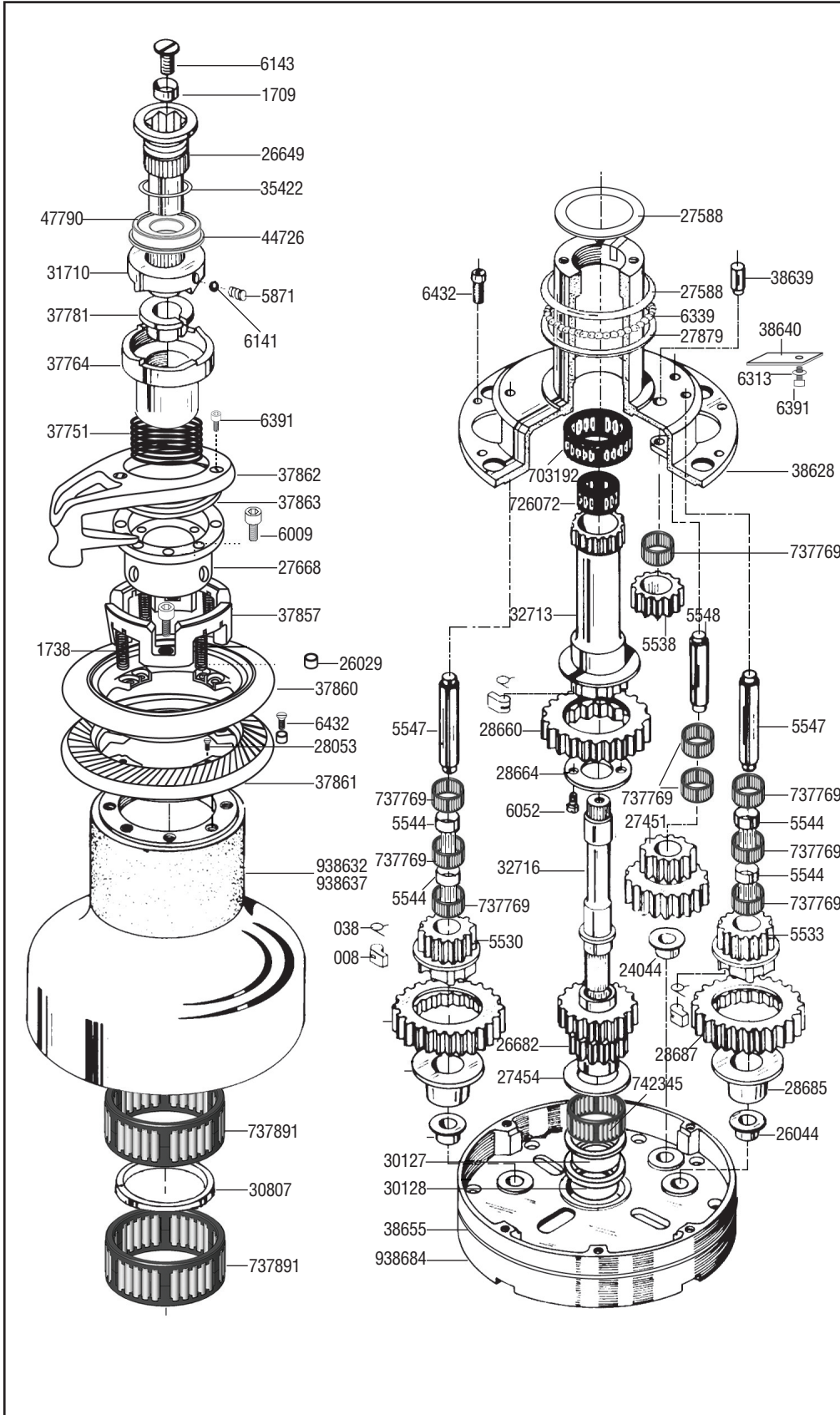

Parts List

008	Pawl
038	Pawl Spring
1709	Plastic Washer
1738	Spring
5530	Pawl Gear
5533	Pawl Gear
5538	Gear
5544	Bearing Spacer
5547	Gear Shaft
5548	Gear Shaft
5871	Spring
6009	Screw
6052	Cover Plate Screw
6141	Ball
6143	Top Screw
6313	Washer
6339	Balls
6391	Screw
6432	Screw
26029	Plastic Washer
26044	Bushing
26649	Handle Socket
26682	Gear
27451	Double Gear
27454	Washer
27588	Thrust Bearing
27668	Stripper Arm Support
27879	Thrust Washer
28053	Plastic Washer
28660	Ratchet Gear
28664	Gear Cover Plate
28683	Ratchet Gear
28685	Gear Base
28687	Ratchet Gear
30127	Bushing
30128	Plastic Bushing
30807	Bearing Spacer
31710	Upper Drive Ring
32713	First Speed Drive Shaft
32716	Center Spindle
35422	Ring
37751	Spring
37764	Lower Drive Ring
37781	Guide Bushing
37857	Spring Support
37860	Upper Jaw
37861	Lower Jaw
37862	Stripper Arm
37863	Cover
38628	Center Stem
38639	Gear Shaft
38640	Stop Plate
38655	Red Line Ring
44726	Logo Support
47790	Top Cap
703192	Bearing
726072	Bearing
737769	Bearing
737891	Bearing
742345	Bearing
938632	Aluminum Drum
938637	Chrome Drum
938684	Base

When ordering parts, please include a "B" before each number (i.e. B008)

Service winch before the sailing season begins and once during.

Required Tools

Screwdriver	Rags
Allen Wrench (6 mm)	Solvent
Allen Wrench (5 mm)	Oil
Plastic Head Hammer or Mallet	Grease
Small Knife	Suggested Service Kits
Brush	BK4512 10 008 Pawls
	10 038 Springs
	BK4513 100 ml Grease

Installing Winch

Make sure mounting surface is flat.
Check sheet entry angle. Should be at least 8° (see drawing).
Open winch.

Position winch on deck with drive gear where sheet enters winch drum. Mark holes.

Remove winch and drill holes.

Mount using six (6) 3/8" (10 mm) flathead machine screws.

Apply bedding compound. Bolt winch to boat.

Clean excess bedding compound from base drain holes.

Lubricate and close winch.

Minimum/Maximum Line Diameter

Harken winches feature spring-loaded self-tailing jaws which adjust automatically to the following line sizes:

Minimum 3/8" (10 mm)

Maximum 13/16" (21 mm)

Positioning Stripper Arm

Loosen top screw (6143).

Remove handle socket (26649).

Lift stripper arm (37858) and position as desired.

Opening Winch

Remove top screw (6143).

Remove handle socket (26649).

Remove 3 screws (6391) in stripper arm (37862).

Remove stripper arm (37862).

Remove 4 screws (6009) in stripper arm base (27668).

Lift support base.

Lift off drum.

Servicing Winch

Remove bearings from center stem.

Drum support bearing 27588/6337/27879 cannot be removed; clean with solvent and lubricate lightly with grease.

Remove allen screws (6432) holding center stem to base.

Remove center stem (38628) carefully.

Remove pawls and springs - service as below.

Remove all bearings, gear shafts and gears.

Service one gear shaft assembly at a time to avoid confusion.

Inspect plastic bushings for wear.

Remove all pawls and springs and service (see below).

Use brush to lubricate all gears, gear shafts, bearings, teeth and all moving parts lightly with grease.

Replace pawls and springs and lubricate lightly with oil.

Assemble and close winch.

Servicing Pawls

Catch spring with knife and hold against pawl.

Lift out pawl.

Clean and check for wear.

Place spring against pawl with straight leg against pawl.

Hold spring closed and slip pawl into pawl socket.

Lubricate pawls using oil.

HARKEN

USA: 1251 E. Wisconsin Ave., Pewaukee, WI 53072 USA • Tel: (262) 691-3320 • Fax: (262) 691-3008 • Web: harken.com • E-mail: harken@harken.com
ITALY: Via Della Cerca, 12/14, 22070 Lurago Marinone, Como, Italy • Fax: (39) 031.3520031 • Tel: (39) 031.3523511 • Web: harken.it • E-mail: info@harken.it

Mounting

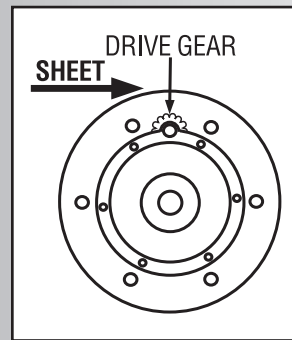

Position drive gear where sheet enters winch drum.

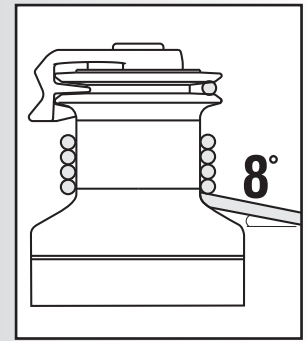

Sheet entry angle must be at least 8°.

Servicing Winch

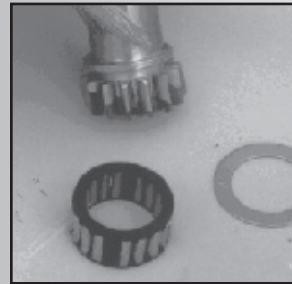

Clean all parts with solvent except 37857/37863.

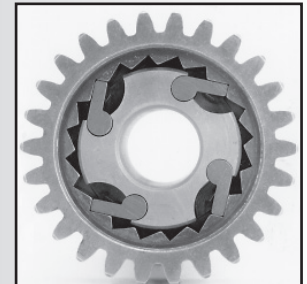

Use a brush to spread a light, even coat of grease.

If ratchet gear is mounted backwards, winch will slip.

Servicing Pawls

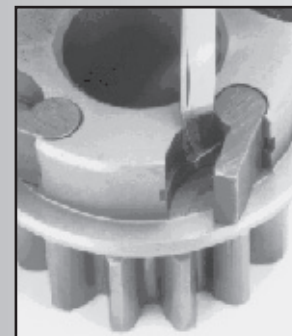

Use knife to free captive spring.

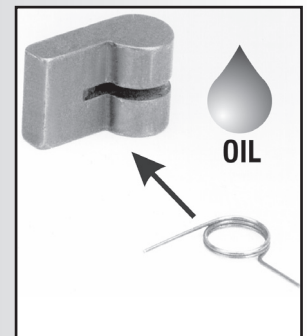

Insert spring with straight leg against pawl. Use oil for lubrication.

WARNING

EN: Do not allow teak cleaning products or other cleaners containing caustic solutions to come into contact with winches and especially anodized, chrome plated or plastic parts.

F: Évitez soigneusement tout contact de nettoyant pour teck ou autres produits de nettoyage avec les winchs et plus particulièrement avec les pièces en aluminium anodisé, en métal chromé ou en plastique.

D: Keine Teak - Reiniger oder andere Reiniger die ätzende Stoffe enthalten, mit Winnschen, eloxierten, verchromten oder Kunststoffteilen in Berührung bringen.

I: Evitare il contatto dei prodotti per la pulizia del teak e di altre sostanze pulenti contenenti soluzioni caustiche con i winch e in particolare con i componenti anodizzati, cromati e plastici dei winch.

E: Evitar que los productos especiales para la limpieza de la Teca o cualquier otro limpiador que contengan soluciones cáusticas, entren en contacto con los Winches y en particular con componentes cromados, plateados o anodizados así como con las piezas de plástico.

4576/4-05

